

Technical Accessory Guides (TAGs)



ZD621D

For Associates, Resellers, ISVs and Alliance Partners

Global



Version: All

Will show products that are known to be available for sale and discontinued products along with suggested replacements, when known

Need to provide an update or change?
Contact
tb3655@zebra.com



For Internal Use by
PartnerConnect Members Only

Proprietary and Confidential. ZEBRA and the stylized Zebra head are trademarks of Zebra Technologies Corp., registered in many jurisdictions worldwide. All other trademarks are the property of their respective owners. ©Zebra Technologies Corp. and/or its affiliates. All rights reserved.

This document and the information contained therein (Information) are Zebra-confidential, and are provided under, and subject to, the confidentiality provision of your PartnerConnect agreement with Zebra. Any public disclosure (via posting on your website or otherwise) of the Information is strictly prohibited and will be considered a violation of your PartnerConnect agreement with Zebra.

Note: This document is only for general reference. Solutions Pathway and related PMBs should be used for product availability, pricing, and final solution selection. Zebra does not endorse or specifically recommend any third-party products, accessories, or hardware. ZEBRA DISCLAIMS ANY AND ALL LIABILITY, INCLUDING ANY EXPRESS OR IMPLIED WARRANTIES, WHETHER ORAL OR WRITTEN, FOR SUCH THIRD PARTY PRODUCTS, ACCESSORIES, OR HARDWARE. THE CUSTOMER ACKNOWLEDGES THAT NO REPRESENTATION HAS BEEN MADE BY ZEBRA AS TO THE FITNESS OF THE THIRD-PARTY PRODUCTS, ACCESSORIES, OR HARDWARE FOR THE CUSTOMER'S INTENDED PURPOSE.

Power Supply, Line Cords, Charging Cables and Power Accessories

| Part Number | Picture | Description | Notes | Required Items |
|--|---|---|--|--|
| P1079903-026 US/EU |  | Power Supply 75W, 24V, with US Cord and EU Cord | <ul style="list-style-type: none"> ▶ Dimensions: 9.05 in. L x 8.26 in. W x 6.49 in. H (23 cm L x 21 cm W x 16.5 cm H) ▶ Weight: 1.43 lbs. (0.65 kg) ▶ 75W, 24V ▶ Compatible Printers: ZD410, ZD420C, ZD420D, ZD420D-HC, ZD420T, ZD620D, ZD620T, GX420D, GX420T, GK888E, GK420E, GX430T, ZD410D, ZD420C, ZD420D, ZD420T, ZD500, ZD500R, ZD620D, ZD620T, ZD621D, ZD621D-HC | |
| P1079903-030 |  | Healthcare  Power Supply, 75W, 24V with US cord, | <ul style="list-style-type: none"> ▶ Dimensions: 9.055123 in. L x 8.267721 in. W x 6.496067 in. H (23 cm L x 21 cm W x 16.5 cm H) ▶ Weight: 1.43 lbs. (0.65 kg) ▶ Compatible Printers: ZD410d-HC, ZD420C, ZD420C-HC, ZD420D, ZD420D-HC, ZD420T-HC, ZD620D-HC, ZD620T-HC, ZD410D, ZD420C, ZD420D, ZD420T, ZD620D, ZD620T, GK420, HC100, ZD510-HC, ZD621D, ZD621D-HC | |
| 105950-014 US 105950-015 EU 105950-029 AU 105950-030 UK 105950-078 CH 105950-079 JP P1033401 BR P1061022-020 IL P1080829 IN P1079903-035 TW |  | AC Power Cable (Set of 5) | <ul style="list-style-type: none"> ▶ Weight: 2.60 lbs. (1.18 kg) ▶ Compatible Printers: ZD410, ZD410d-HC, ZD420C, ZD420C-HC, ZD420D, ZD420D-HC, ZD420T, ZD420T-HC, ZD620D, ZD620D-HC, ZD620T, ZD620T-HC, ZD500, ZD500R, ZD421D, ZD421T, ZD421C, ZD621T, ZD621D, ZD421D-HC, ZD421T-HC, ZD421C-HC, ZD621T-HC, ZD621D-HC | |
| P1080383-430 |  | Attached Power Supply 75W | <ul style="list-style-type: none"> ▶ Attached Power Supply Kits ▶ Weight: 1.96 lbs. / 0.89 kg ▶ Compatible Printers: ZD420D, ZD420D-HC, ZD620D, ZD621D, ZD620D-HC, ZD621D-HC | AC Power Cable 105950-014 US or other region specific cable |

USB and Serial Cables for Communication

| Part Number | Picture | Description | Notes | Required Items |
|-------------|---|---|---|----------------|
| 105850-006 |  | USB Interface Cable, 6FT (A to B) | <ul style="list-style-type: none"> ▶ USB-A to USB-B Cable ▶ Length: 6ft / 1.82 m ▶ Weight: 0.16 lbs. / 0.0742 kg ▶ Compatible Printers: ZD410, ZD420D, ZD420D-HC, ZD420C, ZD420C-HC, ZD420T, ZD420T-HC, ZD620D, ZD620D-HC, ZD620T, ZD620T-HC, ZD410d-HC, ZD510-HC, ZD500R, ZD500, ZD421D, ZD421T, ZD421C, ZD621T, ZD621D, ZD421D-HC, ZD421T-HC, ZD421C-HC, ZD621T-HC, ZD621D-HC | |
| G105850-007 |  | USB Interface Cable, 10FT (A to B) | <ul style="list-style-type: none"> ▶ USB-A to USB-B Cable ▶ Length: 10ft / 3.05 m ▶ Weight: 0.40 lbs. / 0.182 kg ▶ Compatible Printers: ZD410, ZD420C, ZD420C-HC, ZD420D, ZD420D-HC, ZD420T, ZD420T-HC, ZD620D, ZD620D-HC, ZD620T, ZD620T-HC, ZD510-HC, ZD500R, ZD500, ZD421D, ZD421T, ZD421C, ZD621T, ZD621D, ZD421D-HC, ZD421T-HC, ZD421C-HC, ZD621T-HC, ZD621D-HC | |
| G105950-054 |  | Kit Serial Interface Cable, 6FT (DB-9 to DB-9) Null Modem | <ul style="list-style-type: none"> ▶ Serial DB-9 to Serial DB-9 ▶ Length: 6ft / 1.82 m ▶ Weight: 0.46 lbs. / 0.21 kg ▶ Compatible Printers: ZD410, ZD410d-HC, ZD420C, ZD420C-HC, ZD420D, ZD420D-HC, ZD420T, ZD420T-HC, ZD620D, ZD620D-HC, ZD620T, ZD620T-HC, ZD500, ZD500R, ZD421D, ZD421T, ZD421C, ZD621T, ZD621D, ZD421D-HC, ZD421T-HC, ZD421C-HC, ZD621T-HC, ZD621D-HC | |
| 105850-026 |  | Serial Port Adapter | <ul style="list-style-type: none"> ▶ Serial Port Converter ▶ Weight: 0.26 lbs. / 0.12 kg ▶ Compatible Printers: ZD420D, ZD420D-HC, ZD420C, ZD420C-HC, ZD420T, ZD420T-HC, ZD620D, ZD620D-HC, ZD620T, ZD620T-HC, ZD500R, ZD500, ZD421D, ZD421T, ZD421C, ZD621T, ZD621D, ZD421D-HC, ZD421T-HC, ZD421C-HC, ZD621T-HC, ZD621D-HC | |

Connectivity Module

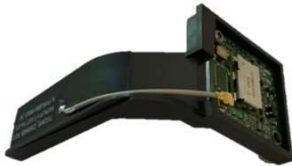
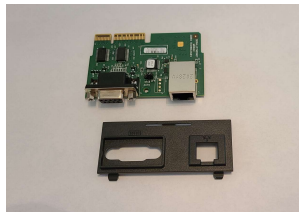

| Part Number | Picture | Description | Notes | Required Items |
|--|--|---|---|----------------|
| <p>P1112640-017A US & Canada P1112640-017B Japan Only P1112640-017C Rest of World</p> |  | <p>Wireless Module, WiFi 802.11ac, MFI 3.0, Bluetooth 4.1</p> | <ul style="list-style-type: none"> ▶ Wireless field upgradeable module ▶ You can get the wireless module pre-installed with your printer at purchase ▶ The door is already part of the printer, hence there is no door included with this module ▶ Dual Radio with 802.11ac and Bluetooth Classic 4.1. ▶ Apple MFI 3.0 certified ▶ Weight: 0.33 lbs. / 0.15 kg ▶ Important: This is <u>not backwards compatible</u> with the ZD420 or ZD620 series ▶ Compatible Printers: ZD421D, ZD621D, ZD421T | |
| <p>P1112640-048</p> |  | <p>Replacement Ethernet and Serial Module</p> | <ul style="list-style-type: none"> ▶ This is a replacement serial and ethernet combination module. The ZD621 base SKU comes pre-installed with combo module. ▶ You can get the serial module pre-installed with your printer at purchase ▶ Weight: 0.54 lbs. / 0.245 kg ▶ Important: This is <u>not backwards compatible</u> with the ZD620 printer series ▶ Compatible Printers: ZD621D | |

Media Handling (Cutters and Peeler (Dispenser))

| Part Number | Picture | Description | Notes | Required Items |
|----------------------------|---|---------------|--|----------------|
| <p>P1112640-030</p> |  | <p>Cutter</p> | <ul style="list-style-type: none"> ▶ Cutter for ZD421 and ZD621 standard and Healthcare direct thermal printers ▶ You can get the cutter pre-installed with the ZD621 printer at purchase, but not pre-installed with the ZD421 ▶ Kit includes: Cutter, Torx T10 and extra screws for installation ▶ Important: This is <u>not backwards compatible</u> with the ZD420 or ZD620 ▶ Weight: 1.47 lbs. / 0.67 kg ▶ Compatible Printers: ZD421D, ZD621D ▶ Note: Printer not included | |



| | | | | |
|---------------------|---|--|--|--|
| <p>P1112640-031</p> |  | <p>Peeler (Dispenser) for ZD421D or ZD621D</p> | <ul style="list-style-type: none"> ▶ Peeler for ZD421 and ZD621 standard and Healthcare direct thermal printers. ▶ Kit includes: Peeler, Torx T10 and extra screws for installation ▶ You can get the peeler pre-installed with the ZD621 printer at purchase, but not pre-installed with the ZD421 ▶ Important: This is <u>not backwards compatible</u> with the ZD420 or ZD620 ▶ Weight: 0.73 lbs. / 0.334 kg ▶ Compatible Printers: ZD421D, ZD621D ▶ Note: Printer not included | |
| <p>P1112640-032</p> |  | <p>Linerless Tear w/ Sensor</p> | <ul style="list-style-type: none"> ▶ Linerless Tear Off Bezel for ZD621 standard and Healthcare direct thermal printers ▶ You can get the cutter pre-installed with the ZD621 printer at purchase, but not pre-installed with the ZD421 ▶ Important: This is <u>not backwards compatible</u> with the ZD620 ▶ Weight: 1.47 lbs. / 0.67 kg ▶ Compatible Printers: ZD621D | |
| <p>P1112640-033</p> |  | <p>Linerless Cutter</p> | <ul style="list-style-type: none"> ▶ Linerless Cutter for ZD621 standard and Healthcare direct thermal printers ▶ You can get the cutter pre-installed with the ZD621 printer at purchase, but not pre-installed with the ZD421 ▶ Kit includes: Cutter, Torx T10 and extra screws for installation ▶ Important: This is <u>not backwards compatible</u> with the ZD620 ▶ Weight: 1.47 lbs. / 0.67 kg ▶ Compatible Printers: ZD621D ▶ Note: Printer not included | |



Routine Maintenance



| Part Number | Picture | Description | Notes | Required Items |
|--------------|--|---|--|----------------|
| 47362 |  | 6 Presaturated Foam Tip Swabs) for Preventative Maintenance | <ul style="list-style-type: none"> ▶ Presaturated Foam Tip Swabs ▶ Unopened, the swabs have a 12-month Shelf Life and must be stored at room temperature (20C-25C) ▶ 99.7% Isopropyl Alcohol (IPA) ▶ Qty 6 ▶ Compatible Printers: ZD410, ZD420C, ZD420C-HC, ZD420T, ZD420T-HC, ZD620D, ZD620T, ZD620T-HC, ZD510-HC, ZD500R, ZD500, ZD621D, ZD621D-HC | |
| 105950-035 |  | Printhead Cleaning Pens (12) | <ul style="list-style-type: none"> ▶ Cleaning Pens for cleaning Printheads ▶ Unopened, the swabs have a 12-month Shelf Life and must be stored at room temperature (20C-25C) ▶ 99.7% Isopropyl Alcohol (IPA) ▶ Qty 12 ▶ Compatible Printers: ZD410, ZD420D, ZD420D-HC, ZD420C, ZD420C-HC, ZD420T, ZD420T-HC, ZD620D, ZD620D-HC, ZD620T, ZD620T-HC, ZD500, ZD500R, ZD621D, ZD621D-HC | |
| P1112640-060 |  | 203dpi Routine Maintenance Kit | <ul style="list-style-type: none"> ▶ Kit includes: 203dpi Printhead (P1112640-050), 203dpi Platen Roller (P1112640-061), & Preventative Maintenance Kit (47362) 6 Presaturated Foam Tip Swabs ▶ Unopened, the swabs have a 12-month Shelf Life and must be stored at room temperature (20C-25C) ▶ Swabs are 99.7% Isopropyl Alcohol ▶ Compatible Printers: ZD621D+D50:D51 | |

Media Core

| Part Number | Picture | Description | Notes | Required Items |
|--------------|---|---|---|----------------|
| P1079903-033 |  | Media Core Adaptors for 1.5, 2" & 3" Diameter Media Cores (set of 2 each) | <ul style="list-style-type: none"> ▶ Direct Thermal Media Core Adaptors for 1.5", 2" & 3" Diameter Media Cores (set of 2 each) ▶ Not Compatible with Thermal Transfer or Cartridge Printers ▶ Kit includes: a left and right media adapter for each size, a Torx T10 and 12 screws for installation ▶ Compatible Printers: ZD410, ZD410D-HC, ZD420D, ZD420D-HC, ZD421D, ZD421D-HC, ZD620D, ZD621D | |

| Printheads | | | | |
|--------------|---|----------------------------------|---|----------------|
| Part Number | Picture | Description | Notes | Required Items |
| P1112640-050 |  | Direct Thermal Printhead, 203dpi | <ul style="list-style-type: none"> ▶ This printhead is included in Routine Maintenance Kit P1112640-060. It is highly recommended that you replace the platen roller and printhead at the same time. Consider purchasing the Routine Maintenance kit instead. ▶ 203dpi Direct Thermal Printhead for ZD621 ▶ Weight: 0.34 lbs. / 0.155 kg ▶ Compatible Printers: ZD621D | |
| P1112640-051 |  | Direct Thermal Printhead, 300dpi | <ul style="list-style-type: none"> ▶ 300dpi Direct Thermal Printhead for ZD621 ▶ Weight: 0.34 lbs. / 0.156 kg ▶ Compatible Printers: ZD621D | |

| Platen Rollers and Platen Roller Bearings | | | | |
|---|---|--------------------------------|---|----------------|
| Part Number | Picture | Description | Notes | Required Items |
| P1112640-061 |  | 203dpi Platen Roller | <ul style="list-style-type: none"> ▶ This platen roller is included in Routine Maintenance Kit P1112640-060. It is highly recommended that you replace the platen roller and printhead at the same time. Consider purchasing the Routine Maintenance kit instead. ▶ 203dpi Platen Roller for Direct Thermal ZD421 and ZD621 ▶ Kit includes: Platen Roller and bearings (one left and one right) ▶ Weight: 0.31 lbs. / 0.14 kg ▶ Compatible Printers: ZD421D, ZD621D, ZD421D-HC, ZD621D-HC | |
| P1112640-062 |  | 300dpi Platen Roller | <ul style="list-style-type: none"> ▶ 300dpi Platen Roller for Direct Thermal ZD421 and ZD621 ▶ Kit includes: Platen Roller and bearings (one left and one right) ▶ Weight: 0.31 lbs / 0.14 kg ▶ Compatible Printers: ZD421D, ZD621D, ZD421D-HC, ZD621D-HC | |
| P1112640-063 |  | Linerless 203dpi Platen Roller | <ul style="list-style-type: none"> ▶ 203dpi Platen Roller for Linerless Direct Thermal ZD621 ▶ Kit includes: Platen Roller and bearings (one left and one right) ▶ Weight: 0.31 lbs. / 0.14 kg ▶ Compatible Printers: ZD621D, ZD621D-HC | |

| | | | | |
|--------------|---|--------------------------------|---|--|
| P1112640-064 |  | Linerless 300dpi Platen Roller | <ul style="list-style-type: none"> ▶ 300dpi Platen Roller for Linerless Direct Thermal ZD621 ▶ Kit includes: Platen Roller and bearings (one left and one right) ▶ Weight: 0.31 lbs / 0.14 kg ▶ Compatible Printers: ZD621D, ZD621D-HC | |
| P1080383-224 |  | Platen Bearings (10 Pack) | <ul style="list-style-type: none"> ▶ Platen Bearings (10 right and 10 left) ▶ Kit, Bearings for the Platen Roller (Left and Right 10 of each) ▶ Qty 10 x right bearing, 10 x left bearing ▶ Weight: 0.18 lbs. / 0.081 kg ▶ Compatible Printers: ZD220, ZD420D, ZD420T, ZD421D, ZD421T, ZD620D, ZD620T, ZD621D, ZD621T, ZD621R, ZD888 | |

Mounting Accessories

| Part Number | Picture | Description | Notes | Required Items |
|--------------|--|-----------------|---|----------------|
| P1080383-423 |  | Adapter bracket | <ul style="list-style-type: none"> ▶ To enable mounting a ZD420/620D in the same location as an existing GK/GX DT is currently mounted. Allows usage of the GK/GX DT hole pattern to mount a ZD420D/620D ▶ Dimensions: 8 in. L x 7.5 in. W x 1.6 in. H (20.32 cm L x 19.05 cm W x 4.06 cm H) ▶ Weight: 1.00 lbs. / 0.454 kg ▶ Compatible Printers: ZD420D, ZD420D-HC, ZD620D, ZD620D-HC, ZD620T, ZD620T-HC, ZD621D, ZD621D-HC | |

Third Party Mounting Accessories

| Part Number | Picture | Description | Notes | Required Items |
|------------------------------------|---|---|---|----------------|
| 215993 ProClip (Third Party) |  | ProClip® Direct Thermal Printer Mount Kit | <ul style="list-style-type: none"> ▶ Includes quick release Speed Clip for easy removal from mounting surface ▶ Pre-drilled holes for AMPS hole patterns ▶ Designed and Manufactured in Sweden ▶ Dimensions: 9.84 (L) x 5.51 (W) x 1.77 (H) (25 cm L x 14 cm W x 4.3 cm H) ▶ Weight: 1.415 lbs. / 0.64 kg ▶ Compatible Printers: ZD420D, ZD420D-HC, ZD421D, ZD620D, ZD620D-HC, ZD621D, ZD421D-HC, ZD621D-HC | |

<https://www.proclipusa.com/collections>

Keyboards

| Part Number | Picture | Description | Notes | Required Items |
|-------------|---|-----------------------|--|----------------|
| ZKDU-001-00 |  | ZKDU ZPL/EPL Keyboard | <ul style="list-style-type: none"> ▶ Dimensions: 9.05 in. L x 8.46 in. W x 4.52 in. H (23 cm L x 21.5 cm W x 11.5 cm H) ▶ Weight: 1.30 lbs. / 0.59 kg ▶ Compatible Printers: ZD410, ZD410-HC, ZD420C, ZD420C-HC, ZD420D, ZD420D-HC, ZD420T, ZD420T-HC, ZD620D, ZD620D-HC, ZD620T, ZD620T-HC, ZD500, ZD500R, ZD621D, ZD621D-HC | |



Carrying Cases

| Part Number | Picture | Description | Notes | Required Items |
|----------------|---|--|--|----------------|
| SG-DM-CASE1-01 |  | Direct Thermal Desktop Printer Carrying Case | <ul style="list-style-type: none"> ▶ Direct Thermal Soft Carrying Case, ZD42X/ZD62X printer with battery attachment ▶ Includes Shoulder Strap, TC5x Sized Holster Pocket ▶ Dimensions: 9.92 in. L x 7.71 in. W x 9.17 in. H 25.2 cm L x 19.6 cm W x 23.3 cm H ▶ Weight: 2.22 lbs. / 1.00 kg ▶ Compatible Printers: ZD420D, ZD620D, ZD421D, ZD621D, ZD420D-HC, ZD620D-HC, ZD421D-HC, ZD621D-HC | |

Batteries

| Part Number | Picture | Description | Notes | Required Items |
|--------------|---|--------------------------|--|---|
| P1080383-603 |  | Battery | <ul style="list-style-type: none"> ▶ Dimensions: 8.46 in. L x 4.13 in. W x 3.62 in. H 21.5 cm L x 10.5 cm W x 9.2 cm H ▶ Weight: 2.42 lbs. / 1.1 kg ▶ Compatible Printers: ZD410, ZD410d-HC, ZD420C, ZD420C-HC, ZD420D, ZD420D-HC, ZD420T, ZD420T-HC, ZD620D, ZD620D-HC, ZD620T, ZD620T-HC, ZD421C, ZD421T, ZD421T-HC, ZD621D, ZD621T, ZD621R | ▶ Base Housing for Battery (P1080383-601) |
| P1080383-601 |  | Base Housing for Battery | <ul style="list-style-type: none"> ▶ Dimensions: 9.84 in. L x 7.48 in. W x 2.75 in. H 25 cm L x 19 cm W x 7 cm H ▶ Weight: 0.99 lbs. / 0.45 kg ▶ Compatible Printers: ZD420D, ZD420D-HC, ZD620D, ZD620D-HC, ZD421D, ZD621D, ZD421D-HC, ZD621D-HC | |